

Easytork Vane Actuator IOM

General

Always refer to the most up-to-date IOM on www.easytork.com

Storage

The Easytork Vane Actuator ("EVA") is a high-quality product and as such must be handled, transported and stored with care. Prior to storage, inspect the actuator for shipping damage. Keep the actuators in their original packing boxes during storage. It is recommended to keep the actuators in a clean and dry environment until ready for use. Store the actuators indoors to protect them from humidity and dust.

Operating Conditions

Lubricants

The actuator's vane seal comes lubricated with grease from the factory and does not require re-lubrication under normal operating conditions.

Air Supply

Instrument Air:

Clean instrument air is to be used. The operating medium is to be filtered to 30 micron particle size or less. Always consult with a representative of EVA for suitability and recommended practice.

Other Media:

Non inert gases cannot be used and will void Easytork's warranty. Pure oxygen, hydrogen, combustible natural gas must not be used.

Corrosive gas cannot be used.

High Cycle Applications:

For high cycle applications, factory recommends using lubricated air and / or re-greasing of internal of actuator. Contact factory for high cycle application.

Piping connected to the actuator or accessories should be fitted according to recommended instrumentation piping practice. Prior to connection, make sure that all lines have no loops and are free of water, oil, or other contaminants that may be trapped in the pipes. Pipes must be flushed with air to clean the passages. Where sealants have been used for threaded connections, care must be taken to avoid excess material from being forced into the actuator ports.

Supply Pressure

The supply pressures for the EVA are as follows:

2-10 bar (30-150 psi).

When sizing an actuator to available air supply, make sure you have adequate power in the actuator to allow the valve to complete its operation and leave enough power for safety margin.

Temperature

The standard EVA has a temperature limits of -20°C (-4°F) to +80°C (+176°F). For temperatures below or above the standard temperature limits please consult with Easytork.

It is essential to use an air dryer for the air supply to avoid any moisture in sub-zero Celsius temperatures.

Humidity and Corrosion

The EVA operates on double acting principle in both double acting or fail-safe functions, therefore the EVA will never create a vacuum effect and pull air from the environment into the actuator.

Speed Regulator

Slower operation of actuator is possible, without significant torque output reduction, by external fitting of flow regulator valves.

Do not overly restrict the exhaust of the EVA, as it may negatively affect the lip seal performance.

Faster operation can be achieved under certain conditions by fitting quick exhaust valves.

High Vibration Area

Apply Loctite on the shaft connect bolt prior to final assembly.

Principle of Operation

The Easytork Vane Actuator is a pneumatic quarter-turn vane actuator. Air pressure applied to the vane surface area generates pure rotary torque.

Air Connection

The actuator air pressure connections are marked **2** and **4**. Port 2 and 4 are NAMUR standard. There are two nest holes marked **Nest** for interface with the air reservoir.

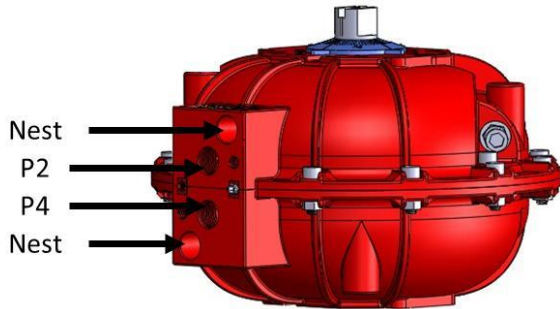

Port 2 and port 4 pass to the vane chamber, the nest holes are connected to the air reservoir chamber. Pressure entering port 4 rotates vane clock wise, pressure entering port 2 rotates vane counter-clockwise.

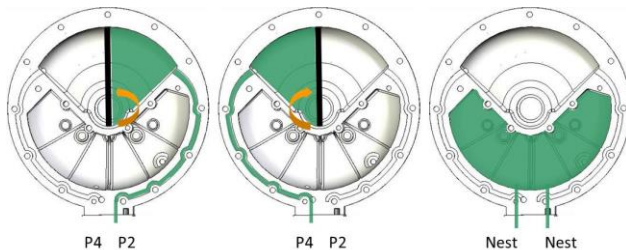

Two direct airline to EVA (double-acting)

Users can directly pipe two airline to actuator, respectively P2 and P4. However, the two Nest holes should be plugged with a M6 allen head to prevent foreign environment getting into the actuator.

One direct airline to EVA (fail-safe)

Users can directly pipe one airline to actuator for fail-safe. EPV must be used in this scenario. Refer to EPV IOM.

Air Reservoir

EVA utilizes an internal air reservoir to assure fail-safe. When there is air failure, the pressurized air stored in the air reservoir is released and diluted with the vane chamber.



Utilizing Air Reservoir for Fail-Safe

The Easytork Solenoid Valve ("ESV"), Easytork Air Pilot Valve ("EPV") and the Easytork Rotary Positioner Valve ("ERP") directly utilize the air reservoir for fail-safe. Refer to each individual IOM for additional information.

Non-Easytork Solenoid Valve

NAMUR interface allows non-Easytork solenoid valve in the market to be installed, but access to air reservoir for fail-safe is not available unless paired with an EPV.

Double acting with non-Easytork NAMUR solenoid valve

The NAMUR interface on EVA allows other 5/2 solenoid valve in the market to be installed for double-acting applications.

Double-Acting with Non-Easytork Solenoid Valve

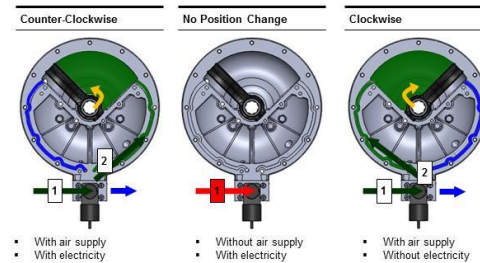

Fail-safe with non-Easytork solenoid valve

Non-Easytork solenoid valves cannot directly utilize the air reservoir. Therefore fail-safe with non-Easytork solenoid valves is not possible.

An EPV can be purchase separately. EPV can connected to any remotely mounted 3/2 solenoid valve (panel, built or attached to limit switch box conduit), this allows users to achieve fail-safe function without using the ESV.

Installation

EVA Installation with ESV, EPV, and ERPV

Refer to each individual IOM for additional information.

EVA Installation with Non-Easytork Solenoid Valve

Ensure that both nest holes are properly plugged and that the air reservoir is not in use. The solenoid valve should be installed in accordance with instructions from the manufacturer.

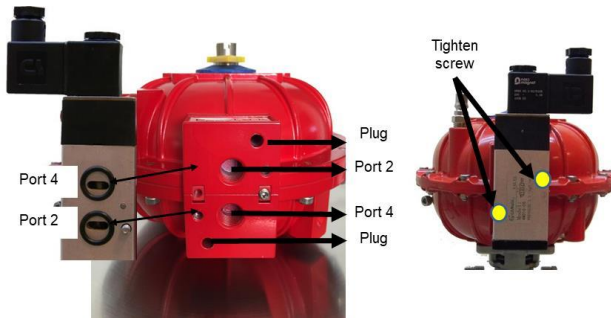

Caution: When air reservoir is not in use, EVA's nest holes should be plugged to prevent foreign elements from entering.

Installation – EVA to Valve

ISO 5211 or DIN3337

EVA actuators are in accordance with ISO5211 (or DIN3337) international standard and can incorporate various shaped female drives

The following ISO 5211 standard table shows the maximum torques transmittable for each flange connection and the preferred square head.

Flange		Preferred Sq. Head (1)	
Flange	Max Flange torque (NM)	Size	Max transmissible torque (NM)
F03	32	9mm	32
F04	63	11mm	63
F05	125	14mm	125
F07	250	17mm	250
F10	500	22mm	500
F12	1,000	27mm	1,000
F14	2,000	36mm	2,000
F16	4,000	46mm	4,000

Note (1): Maximum transmissible torque figures are based on a maximum allowable torsional stress of 280 MPa for the driven component.

Caution: Do not exceed the maximum torque transmittable for specified flange pattern. Exceeding the maximum torque transmittable may damage the actuator body or drive insert.

EVA Selection

The suggested safety factor for the double acting and fail-safe version in normal working conditions is 15-20%. Actuator is designed to continuously operate no less than 15% of specified air pressure.

End Loading

There must be no end load on actuator drive shaft. Check clearance between actuator and driven unit drive shaft. When the mounting is tightened down, check there is end play to avoid end load on actuator shaft.

High Performance Butterfly Valve

The EVA can only be used to fail-safe close position a high performance butterfly valve when the high performance butterfly valve seat retainer is downstream. The EVA can only be used to fail-safe open position a high performance butterfly valve when the high performance butterfly valve seat retainer is upstream. All other setup cannot be used and will void Easytork's warranty.

Adapting EVA for Valve

Removing Drive Insert

All actuators are fitted with removable drive inserts in order to accommodate different valve stem profiles.

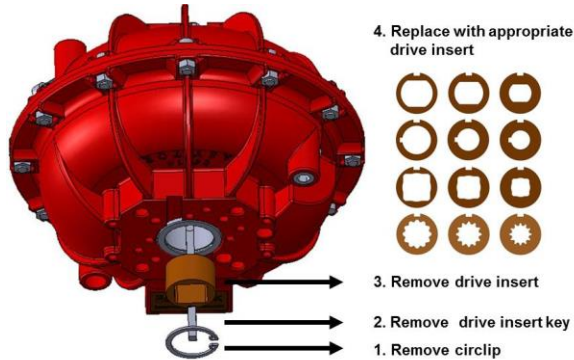

Drive Insert Puller Socket Tool

Note the drive inserts are tightly fitted into the shafts. In the event the inserts cannot be pulled out by hand, Easytork supplies a drive insert puller socket tool for easier drive insert pullout.

1. First begin by removing circlip holding drive insert in place.

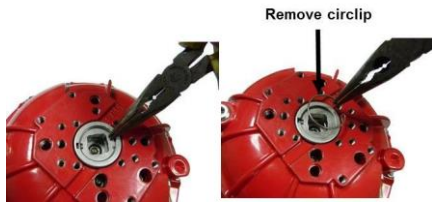

2. If inserts cannot be moved out by hand, insert drive insert removal; turn 45° to engage the groove inside the drive insert.



3. Use spanner to turn the bolt and pull the drive insert.



Installing a New Drive Insert

Make sure circlip and key are reinstalled along with the new drive insert in the shaft.

Caution: Make sure shaft slot is parallel to the pipe axis while the valve is open. Shaft slot must indicate valve axis. Drive insert must correctly align relative to shaft slot.

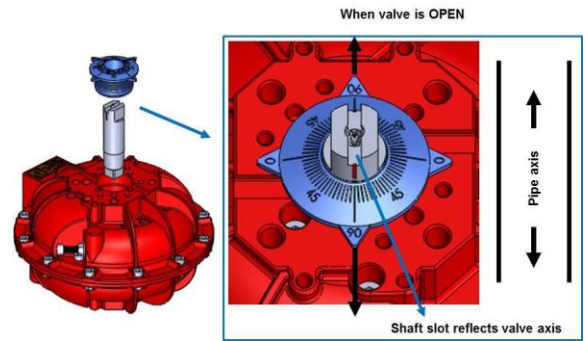

Upper & Lower Shaft Adaptation / Position Indicator Adaptation

Users can swap out the upper or lower shaft for custom needs.

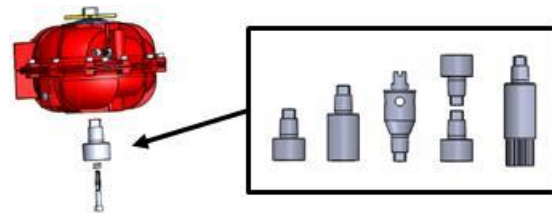

Shaft Removal Process

Note the tapered surfaces of the upper and lower shafts are tightly engaged to the tapered surface of the vane. Similar to a drill press, users would need to knock out both the upper and lower shafts to disengage the taper-to-taper contact.

1. First remove the shaft connect bolt.



- Tighten the upper shaft removal bolt to the upper shaft. Then in a quick and definitive pull, pull on the shaft remover. You will feel the upper shaft come loose. Remove upper shaft from actuator.

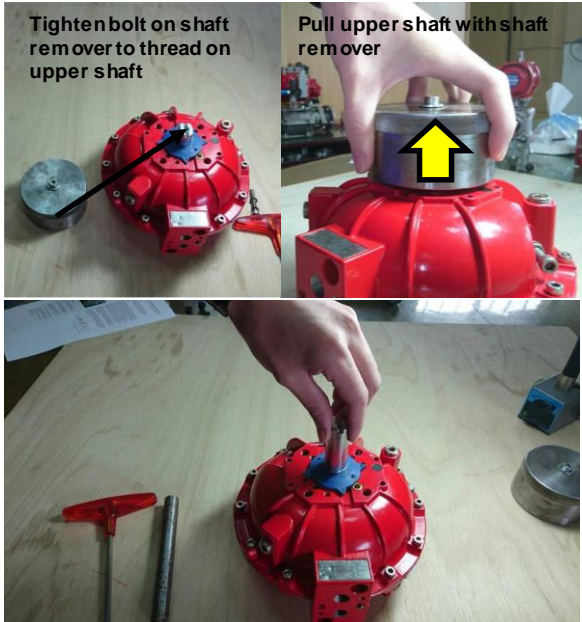

Caution: Ensure plenty of threading is engaged between upper shaft and shaft puller to prevent threads from being stripped.

- Remove the blue graduated ring.

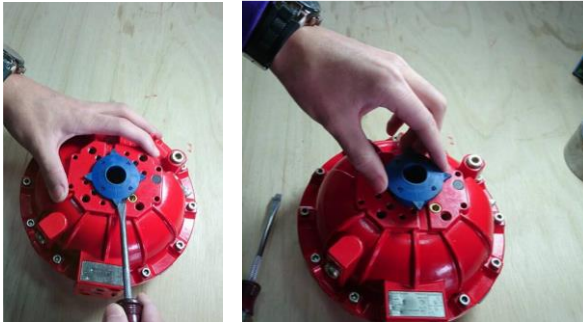

Note: In many cases, it is not necessary to remove blue ring.

- Using a rod, from the upper shaft cavity quickly and definitively knock out the lower shaft. Lower shaft will come loose from taper engagement. Picture shown here uses a hammer and a rod.

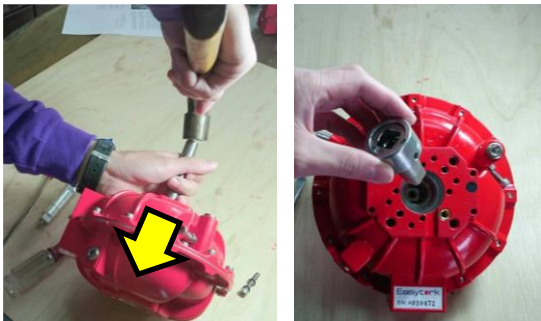

Shaft Installation Process

Caution: Make sure shaft slot is parallel to the pipe axis while the valve is open. Shaft slot must indicate valve axis. Drive insert must correctly align relative to shaft slot.

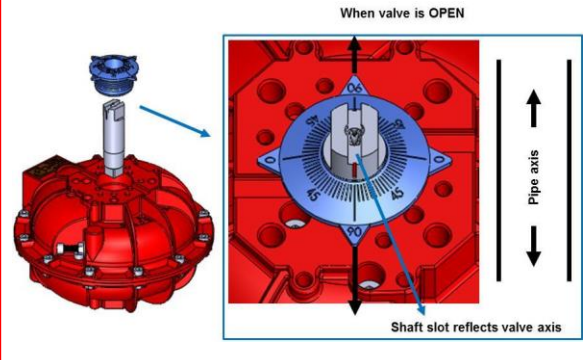

- Install upper shaft and blue graduated ring back into actuator.

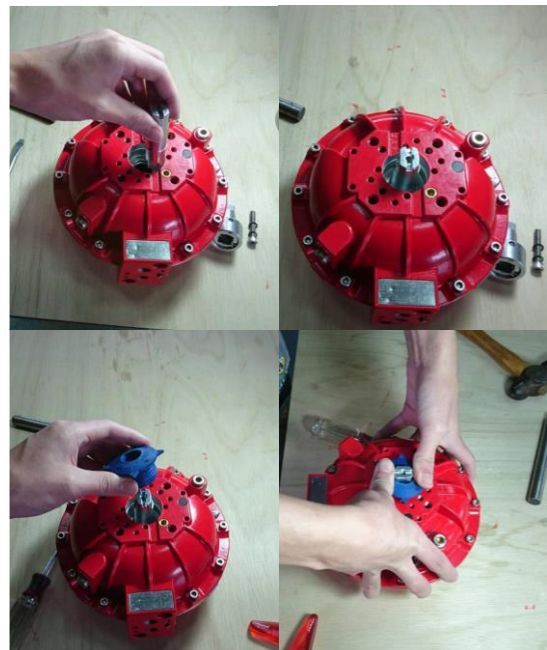

2. Place lower shaft back into actuator, tighten upper and lower shaft with bolt based on the guidance below, and ensure washer is included. This will re-engage the taper-to-taper contact between the upper shaft with the vane shaft assembly, and the lower shaft with the vane shaft assembly.

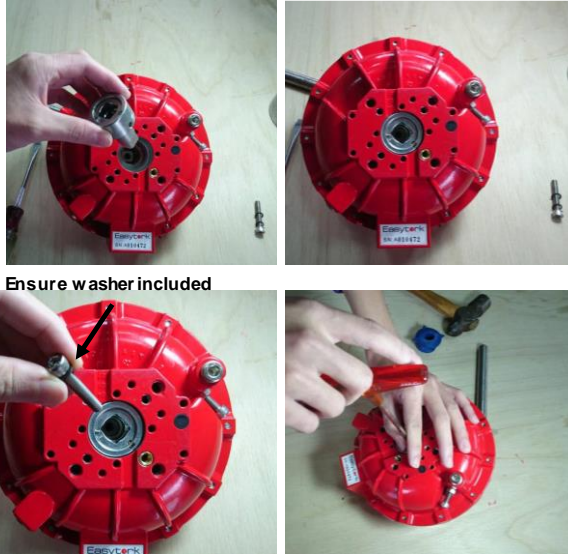

Ensure washer included

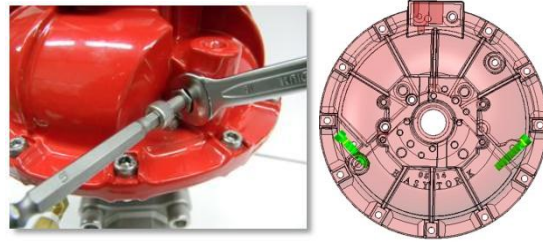

Actuator Connection to Valve or Bracket

Use the following chart to fasten the bolt and nut to connect the actuator to either the valve or bracket.

Bolt	NM	Bolt	Ft/Lb
M5	5 – 6	10-24UNC	3.7 – 4.4
M6	10 – 11	1/4-20	7.4 – 8.1
M8	23 – 25	5/16-18	17.0 – 18.5
M10	48 – 52	3/8-16	35.5 – 38.5
M12	82 – 86	1/2-13	60.7 – 63.6
M16	200 – 210	5/8-11	148.0 – 155.4
M20	390 – 410	3/4-10	288.6 – 303.4

Identification and Marking

Allowable Shaft Connect Bolt Torque

To avoid accidentally shifting the vane when tightening the upper and lower shaft, make sure shaft connect bolt is not too tightly torqued, it should just be snug. Shaft connect bolt should be tightened to the following torque.

Bolt	NM	In-Lb
M5	1.3	11.3
M6	2.5	22.5
M8	5.8	51.0
M10	12.0	106.3
M12	20.5	181.5
M16	50.0	443.0

Travel Adjustment

The actuator is factory adjusted to produce 90° rotation. Actuator warranty and rotation is designed to be restricted by the stopper bolt and nut set. The adjustment of +/- 5° (is standard) in the travel limits per each stopper bolt. Other intermediate positions can be achieved with a long set of stopper bolts and are available on request.

In the event that rotation is not limited by actuator stopper bolt, (ie; stopping on valve or damper hard stop built into customers assembly) welding the drive insert to the lower shaft can significantly improve the structural integrity of the actuators (and limit damage to the actuator).

Caution: Ensure proper sealing before operation.

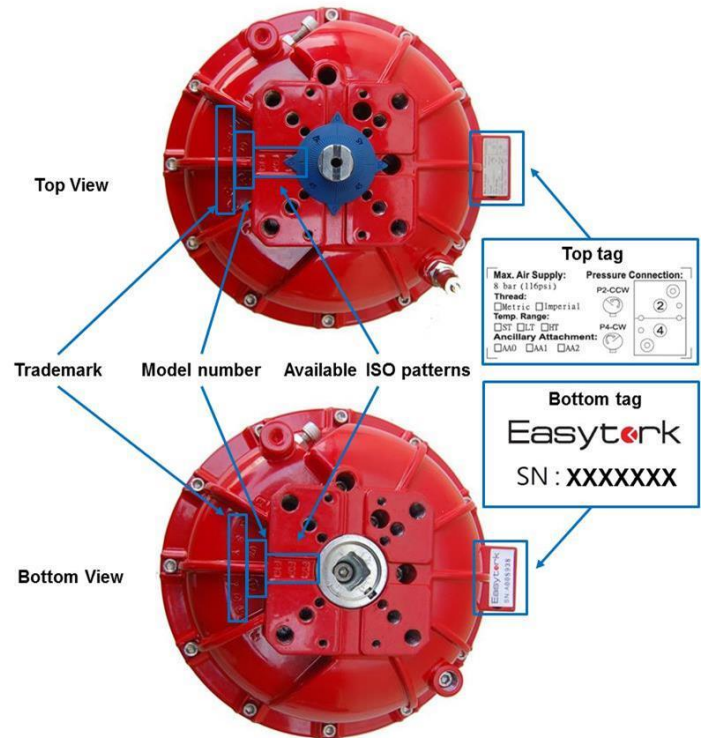

Maintenance

Maintenance is limited to replacement of seals when wear affects actuator performance. Seal life will vary according to application, conditions of cycle frequency, temperature, condition of air supply, etc.

Disassembly

General

Note: Easytork's warranty and liability of the EVA are voided with the disassembly of the product.

Before performing any disassembly operation, make sure you read all the warnings and safety instructions in this booklet.

Do not attempt to disassemble the actuator while it is still connected to the valve or to any ancillary. Verify that the actuator is not pressurized. Work in a clean area, free of dust, debris, grease, corrosives and moisture. For security and comfort, do the repairs on a table with a vice.

1. Remove all bolts.

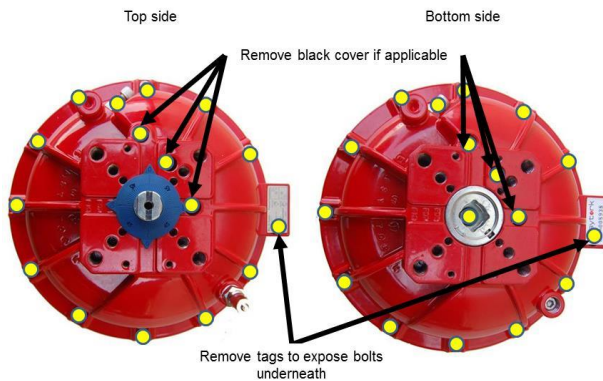

2. Remove upper shaft, lower shaft and position indicator.
3. After step 1 and 2 are complete, supply an airline directly to port 2 or port 4 of the actuator to blow apart the two actuator halves.

Caution: Start from low pressure and gradually build pressure. A high pressure would blow apart the actuator halves at higher velocity. Cover actuator when applying air pressure to prevent accidental collateral damage. A loud pop is normal. Ensure no part of your body is near the actuator, and do not hover on top of the actuator.

4. Remove the vane.
5. Clean both case halves, removing sealant.

Assembly

General

Before performing assembly, clean the grease in all the actuator parts. The surface should be smooth and without any

damage, debris, rust or other containments. This may affect the glue, causing air pressure leakage.

1. Evenly coat machined surface with the provided sealant in the replacement kit package.

Caution: Excess sealant, if extruded inside, will impair operation of seals. Remove all excess sealant especially from inside edge.

(Coat entire surface with sealant)



2. Insert two plastic locator inserts. Coat new vane and housing with grease supplied by Easytork. Insert vane into vane compartment.

Insert two plastic locator inserts



Coat vane and vane housing with grease

3. Combine and compress two compartments guided by the two location pins.
4. Use tightening torque table to fasten all the connecting bolts.

Bolt	NM	Ft/Lb
M5	5 – 6	3.7 – 4.4
M6	10 – 11	7.4 – 8.1
M8	23 – 25	17.0 – 18.4
M10	48 – 52	35.4 – 38.4
M12	82 – 86	60.5 – 63.4
M16	200 – 210	147.5 – 154.9
M20	390 – 410	287.6 – 302.4

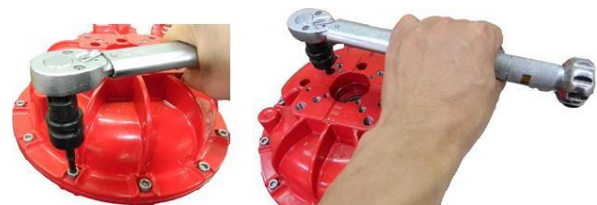

5. Rotate vane manually to check movement and wipe away extruded sealant.
6. Allow sealant to set for at least 24 hours before applying test air pressure.

Actuator Testing

After completing actuator assembly, it is mandatory to follow the testing procedures listed below to ensure that the actuator has been correctly assembled.

Vane Leak Test

Any leakage across the vane is not acceptable.

1. Apply the pressure to port 2 and leave port 4 open.
2. Apply a leak-testing soap solution to port 4 and check for leakage.
3. Repeat this by applying pressure to port 4 and check port 2 for leakage.
4. If leakage is observed, disassemble the actuator again and check the seals, surface finish and cleanliness of the internal parts to find the cause of leakage. After doing the repair work, the leakage test must be performed again.

External Leak Test

Install the ESV to EVA and apply the pressure to port 1, in both open and close positions. Spray leak-testing soap solution on the housing joint (or rinse in the water) to check for bubbles to ensure that no external leakage occurred.

If there is no internal and external leakage, proceed to the rest of the assembly for upper and lower shafts and position indicator.

TWO YEAR OR TWO MILLION CYCLE WARRANTY

Note: Easytork's warranty and liability of the EVA are voided if there are damages caused by negligence, misuse, improper application, service or operation or lack of service of product.

EASYTORK offers a limited repair or replacement warranty on all EASYTORK Vane Actuator (EVA) Series, Easytork Solenoid Valve (ESV) Series, and Easytork Air Pilot Valve (EPV) Series (the "Products"). Simply stated, if any of Goods fails within two years or two million cycles, whichever comes first, of delivery by Distributor, despite being properly installed, operated in accordance with industry standard operating procedures, and properly serviced and maintained, EASYTORK will repair the product, or at our option replace the unit with another of equivalent material and design in exchange for the defective unit. This warranty only applies to failures due to defective materials, workmanship, or premature wear in the Goods.

Under no circumstances will EASYTORK accept responsibility or be liable for any costs other than to repair or provide a replacement of the defective Goods. EASYTORK shall not have any liability to any customer for the loss of product, loss of profit, loss of use, or any other indirect, incidental, special or consequential damages as a result of this express limited warranty.

Actuator is designed to continuously operate within 15% of specified air pressure in either DA or FS design.

EASYTORK DISCLAIMS ANY WARRANTY OF MERCHANTABILITY OR FITNESS FOR A PARTICULAR PURPOSE OR ANY OTHER IMPLIED WARRANTY IN CONNECTION WITH THE CUSTOMER'S PURCHASE OF ANY PRODUCT UNDER THIS AGREEMENT.

Parts List

Ref No	Description	Standard Version	Chemical Version	Quantity
1	Yellow position & degree indicator	NBR	NBR	1
2	Blue graduated ring	NBR	NBR	1
3	Upper shaft	Nickel-plated steel	Stainless steel	1
4	Connecting bolt & nut	Stainless steel	Stainless steel	1 lot
5	Plug	Nickel-plated steel	Stainless steel	1 lot
6	Housing	Aluminum A383 / epoxy external & internal finish	Aluminum A383 / PTFE external & internal finish	2
7	Vane / shaft bearing	PTFE lined steel baked bronze bushing	PTFE lined steel baked bronze bushing	2
8	Vane / shaft assembly*	Stainless steel bonded with silicone	Stainless steel bonded with silicone	1
9	Location pin	Mild steel	Mild steel	2
10	Stopper bolt and nut set	Stainless steel	Stainless steel	2
11	Lower shaft	Nickel-plated steel	Stainless steel	1
12	Drive insert lower	Nickel-plated steel	Stainless steel	1
13	Drive insert circlip	Stainless steel	Stainless steel	1
14	Bellville washer	High tensile steel	High tensile steel	1
15	Shaft connect bolt	Stainless steel	Stainless steel	2
16	Drive insert key	Key/steel	Key/steel	1
17	Tag plate*	Stainless steel	Stainless steel	1
18	Locator insert*	Plastic	Plastic	2
19	Main solenoid valve	(See ESV for details)	(See ESV for details)	2

* Items marked with an asterisk are included in repair kit.

